

IS31AP2145A

2.9W@5.0V MONO CLIP-LESS & FILTER-LESS CLASS-D AUDIO POWER AMPLIFIER

December 2011

GENERAL DESCRIPTION

The IS31AP2145A is a 2.9W@5.0V mono, clip-less, filter-less, high efficiency Class-D audio power amplifier with automatic gain control.

The IS31AP2145A integrates AGC (Automatic Gain Control) function to automatically prevent distortion of the audio signal by which we can enhance audio quality and also protect the speaker from damage at high power levels. The AGC function and its attack time/release time are selectable via the CTRL pin. The IS31AP2145A also provides thermal and over current protection functions.

In addition to these features, 90% high efficiency, improved RF-rectification immunity, a fast start-up time and small package size make IS31AP2145A ideal choice for cellular handsets, PDAs and other portable applications.

IS31AP2145A is available in a 1.5mm×1.5mm UTQFN-9 package.

FEATURES

- Filter-less Class-D architecture
- AGC enable/disable function
- 2.9W into 4Ω at 5.0V (10% THD+N)
- Power supply range: 2.7V to 5.5V
- Selectable attack and release times
- Minimum external components
- High efficiency: 90%
- Click-and-pop suppression
- Low shutdown current: 0.1μA
- Short-circuit and thermal protection
- Space-saving UTQFN-9, 1.5mm × 1.5mm

APPLICATIONS

- Wireless or cellular handsets and PDAs
- Portable navigation devices
- Portable DVD player
- Notebook PC
- Educational toys
- USB speakers
- Portable gaming

TYPICAL APPLICATION CIRCUIT

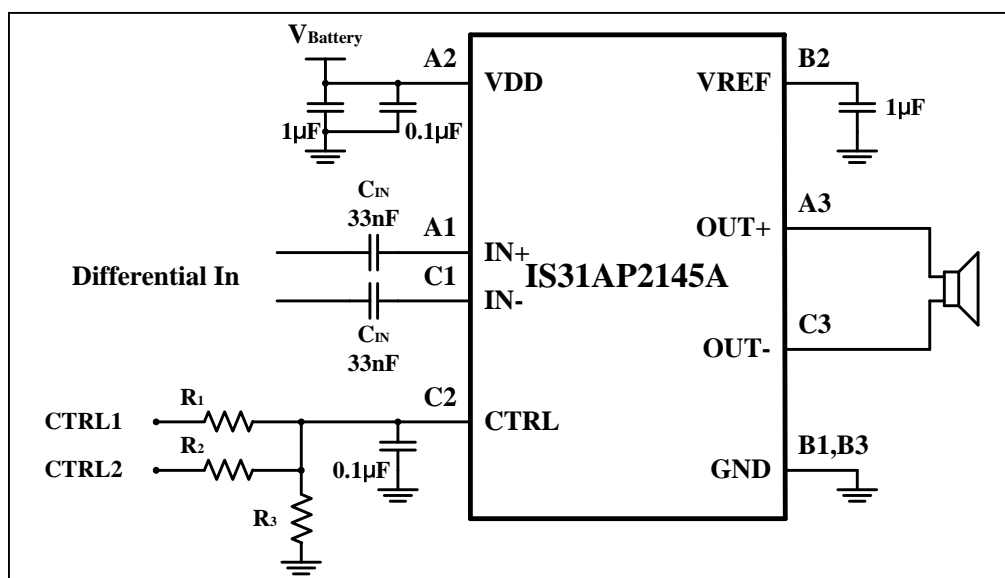

Figure 1 Typical Application Circuit (Differential Input)

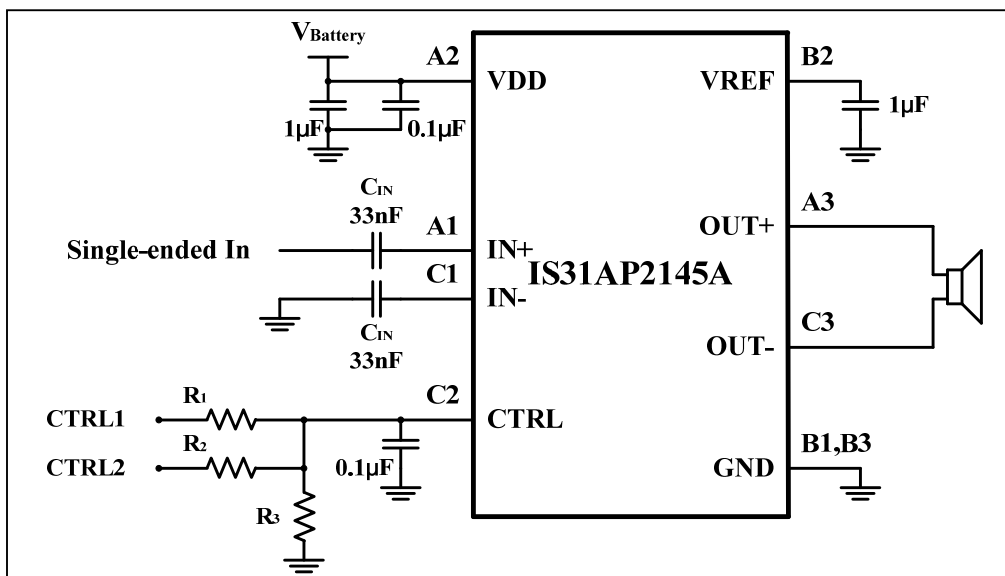
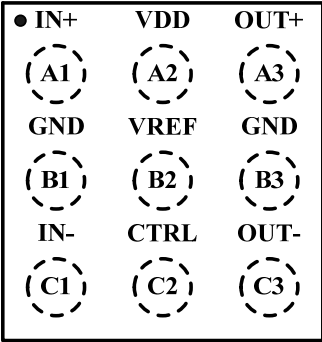

Figure 2 Typical Application Circuit (Single-Ended Input)

IS31AP2145A

PIN CONFIGURATION

Package	Pin Configuration (Top View)
UTQFN-9	 <p> • IN+ VDD OUT+ (A1) (A2) (A3) GND VREF GND (B1) (B2) (B3) IN- CTRL OUT- (C1) (C2) (C3) </p>

PIN DESCRIPTION

No.	Pin	Description
A1	IN+	Positive input terminal.
A2	VDD	Power supply.
A3	OUT+	Positive output terminal.
B1, B3	GND	Ground.
B2	VREF	Analog reference power supply terminal.
C1	IN-	Negative input terminal.
C2	CTRL	Power down and AGC control terminal.
C3	OUT-	Negative output terminal.

Copyright © 2011 Integrated Silicon Solution, Inc. All rights reserved. ISSI reserves the right to make changes to this specification and its products at any time without notice. ISSI assumes no liability arising out of the application or use of any information, products or services described herein. Customers are advised to obtain the latest version of this device specification before relying on any published information and before placing orders for products. Integrated Silicon Solution, Inc. does not recommend the use of any of its products in life support applications where the failure or malfunction of the product can reasonably be expected to cause failure of the life support system or to significantly affect its safety or effectiveness. Products are not authorized for use in such applications unless Integrated Silicon Solution, Inc. receives written assurance to its satisfaction, that:

- a.) the risk of injury or damage has been minimized;
- b.) the user assume all such risks; and
- c.) potential liability of Integrated Silicon Solution, Inc is adequately protected under the circumstances



IS31AP2145A

ORDERING INFORMATION

Industrial Range: -40°C to +85°C

Order Part No.	Package	QTY/Reel
IS31AP2145A-UTLS2-TR	UTQFN-9, Lead-free	3000



IS31AP2145A

ABSOLUTE MAXIMUM RATINGS (NOTE 1)

Supply voltage, V_{DD}	-0.3V ~ +6.0V
Voltage at any input pin	-0.3V ~ $V_{DD}+0.3V$
Junction temperature, T_{JMAX}	150°C
Storage temperature range, T_{STG}	-65°C ~ +150°C
Operating temperature range	-40°C ~ +85°C
ESD (HBM)	7kV

Note:

Stresses beyond those listed under "Absolute Maximum Ratings" may cause permanent damage to the device. These are stress ratings only and functional operation of the device at these or any other condition beyond those indicated in the operational sections of the specifications is not implied. Exposure to absolute maximum rating conditions for extended periods may affect device reliability.

ELECTRICAL CHARACTERISTICS

$T_A = -40^\circ\text{C} \sim +85^\circ\text{C}$, $V_{DD} = 2.7V \sim 5.5V$, unless otherwise noted. Typical value are $V_{DD} = 3.6V$, $T_A = +25^\circ\text{C}$.

Symbol	Parameter	Condition	Min.	Typ.	Max.	Unit
V_{DD}	Supply voltage		2.7		5.5	V
I_{DD}	Quiescent current			2		mA
I_{SD}	Shutdown current	$V_{CTRL} = 0V$		0.1		μA
f_{SW}	Switching frequency	$V_{DD} = 2.7V \sim 5.5V$		300		kHz
Gain	Audio input gain			18		dB

AGC Characteristics

V_{AGC1}	AGC1 mode setting threshold voltage		1.4		V_{DD}	V
V_{AGC2}	AGC2 mode setting threshold voltage		0.64		1.05	V
V_{OFF}	AGC OFF mode setting threshold voltage		0.36		0.6	V
V_{SD}	Shutdown mode setting threshold voltage		0		0.14	V
t_{AT1}	Attack time 1			45		ms
t_{RT1}	Release time 1			2.6		s
t_{AT2}	Attack time 2			10		ms
t_{RT2}	Release time			1.2		s
A_{MAX}	Maximum attenuation gain			-10		dB

IS31AP2145A

ELECTRICAL CHARACTERISTICS

AGC OFF, $T_A = +25^\circ\text{C}$, $V_{DD} = 3.6\text{V}$, unless otherwise noted.

Symbol	Parameter	Condition	Min.	Typ.	Max.	Unit	
P_O	Output power	THD+N = 10%, $f = 1\text{kHz}$ $R_L = 4\Omega + 33\mu\text{H}$	$V_{DD} = 5.0\text{V}$		2.90		W
		THD+N = 1%, $f = 1\text{kHz}$ $R_L = 4\Omega + 33\mu\text{H}$	$V_{DD} = 5.0\text{V}$		2.30		W
		THD+N = 10%, $f = 1\text{kHz}$ $R_L = 8\Omega + 33\mu\text{H}$	$V_{DD} = 5.0\text{V}$		1.68		W
		THD+N = 1%, $f = 1\text{kHz}$ $R_L = 8\Omega + 33\mu\text{H}$	$V_{DD} = 5.0\text{V}$		1.38		W
THD+N	Total harmonic distortion plus noise	$V_{DD} = 3.6\text{V}$, $P_O = 0.5\text{W}$, $R_L = 8\Omega + 33\mu\text{H}$ $f = 1\text{kHz}$		0.165		%	
		$V_{DD} = 3.6\text{V}$, $P_O = 1.0\text{W}$, $R_L = 4\Omega + 33\mu\text{H}$ $f = 1\text{kHz}$		0.175			
PSRR	Power supply rejection ratio	$V_{P-P} = 200\text{mV}$, $R_L = 8\Omega$, $f = 217\text{Hz}$		-72		dB	
		$V_{P-P} = 200\text{mV}$, $R_L = 8\Omega$, $f = 1\text{kHz}$		-65		dB	
η	Maximum efficiency	$P_O = 1.0\text{W}$, $R_L = 8\Omega + 33\mu\text{H}$, $f = 1\text{kHz}$		90		%	
t_{ST}	Start-up time			34		ms	
t_{WK}	Wake-up time		40			ms	
t_{SD}	Shutdown time		80			ms	
t_{MOD}	Mode switching time		0.1			ms	

IS31AP2145A

TYPICAL PERFORMANCE CHARACTERISTICS

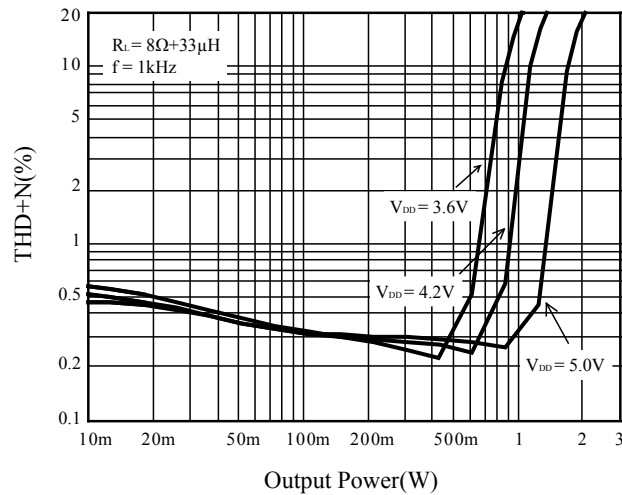

Figure 3 THD+N vs. Output Power

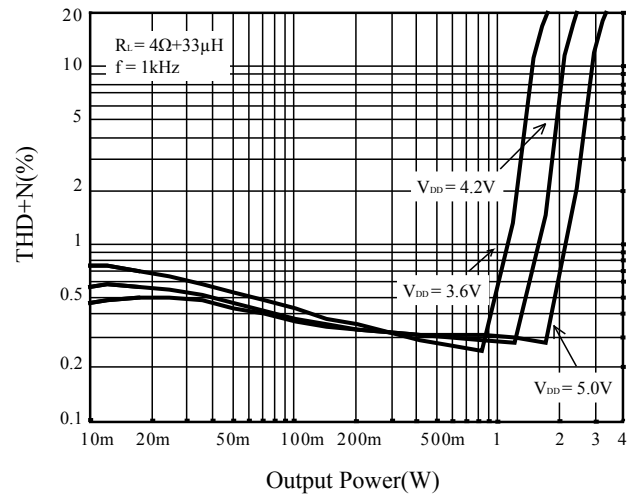

Figure 4 THD+N vs. Output Power

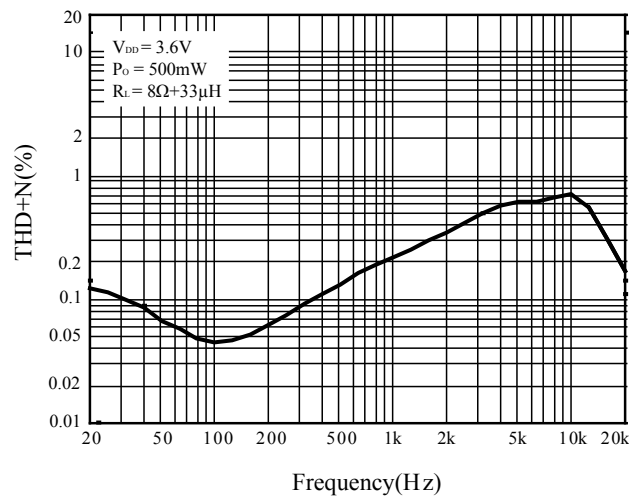

Figure 5 THD+N vs. Frequency

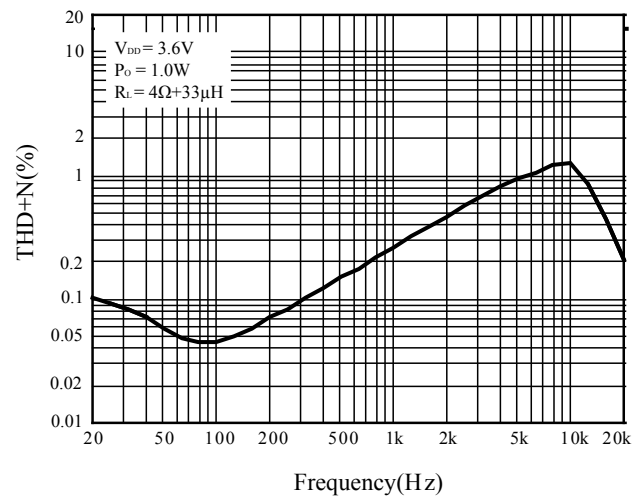

Figure 6 THD+N vs. Frequency

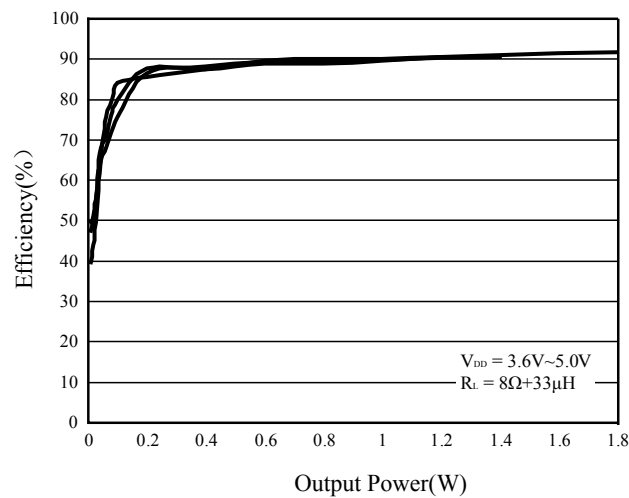

Figure 7 Efficiency vs. Output Power

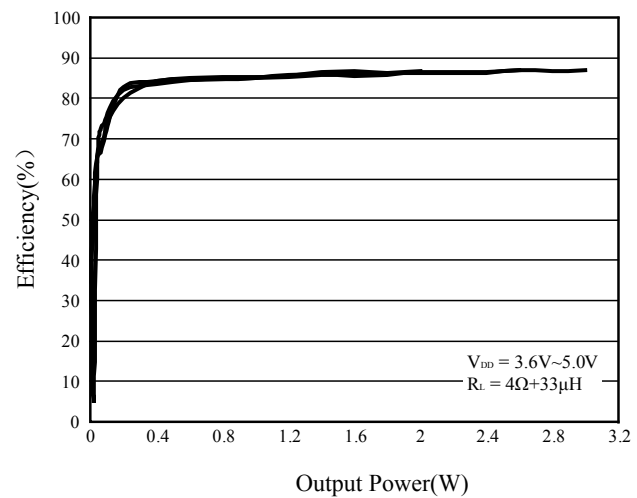

Figure 8 Efficiency vs. Output Power

IS31AP2145A

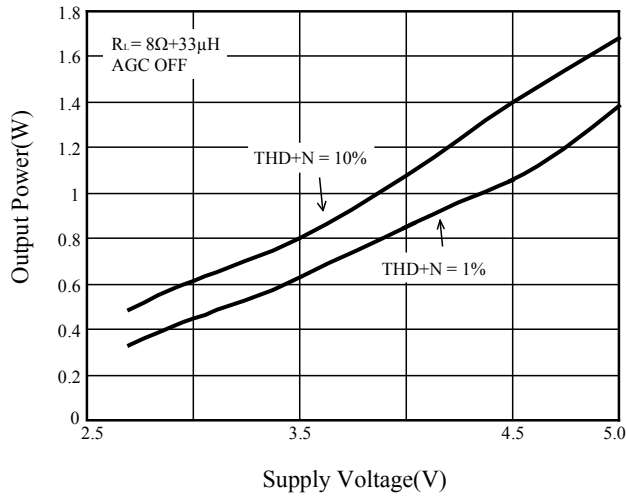

Figure 9 Output Power vs. Supply Voltage

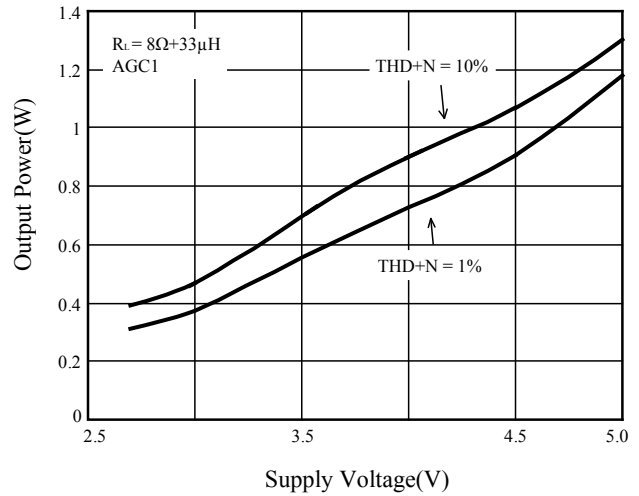

Figure 10 Output Power vs. Supply Voltage

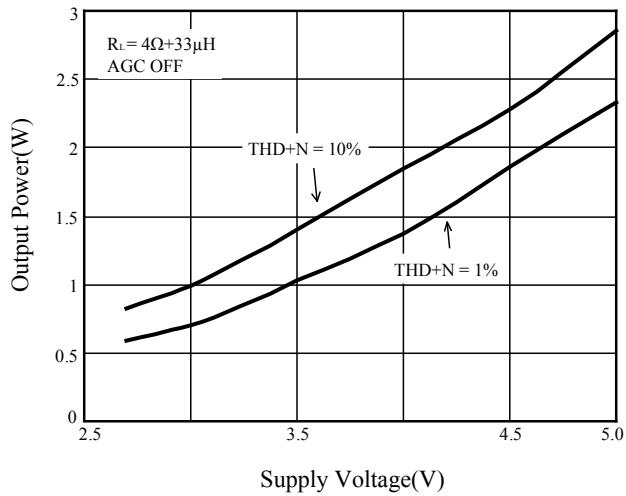

Figure 11 Output Power vs. Supply Voltage

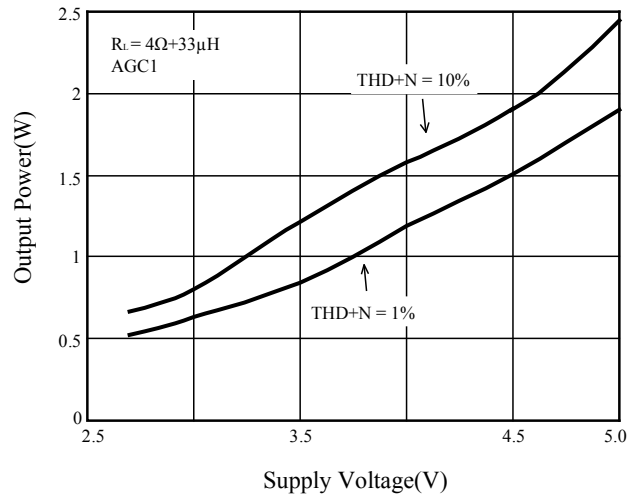

Figure 12 Output Power vs. Supply Voltage

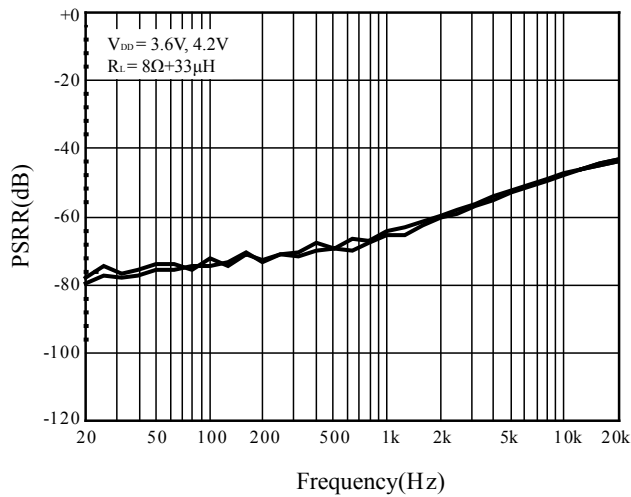

Figure 13 PSRR vs. Frequency

IS31AP2145A

APPLICATION INFORMATION

DIGITAL AMPLIFIER

The IS31AP2145A is a 2.9W@5.0V mono, clip-less, filter-less, high efficiency Class-D audio power amplifier with automatic gain control.

The IS31AP2145A integrates AGC (Automatic Gain Control) function to automatically prevent distortion of the audio signal by which we can enhance audio quality and also protect speaker from damage at high power levels. In addition, IS31AP2145A has been designed so that high-efficiency can be maintained within an average power range that is used for mobile terminal.

AGC (AUTOMATIC GAIN CONTROL) CONTROL FUNCTION

This is the function to control the output in order to obtain a maximum output level without distortion when an excessive input is applied which would otherwise cause clipping at the differential signal output. That is, with the AGC function, IS31AP2145A lowers the gain of the digital amplifier to an appropriate value so as not to cause clipping at the differential signal output (Figure 14).

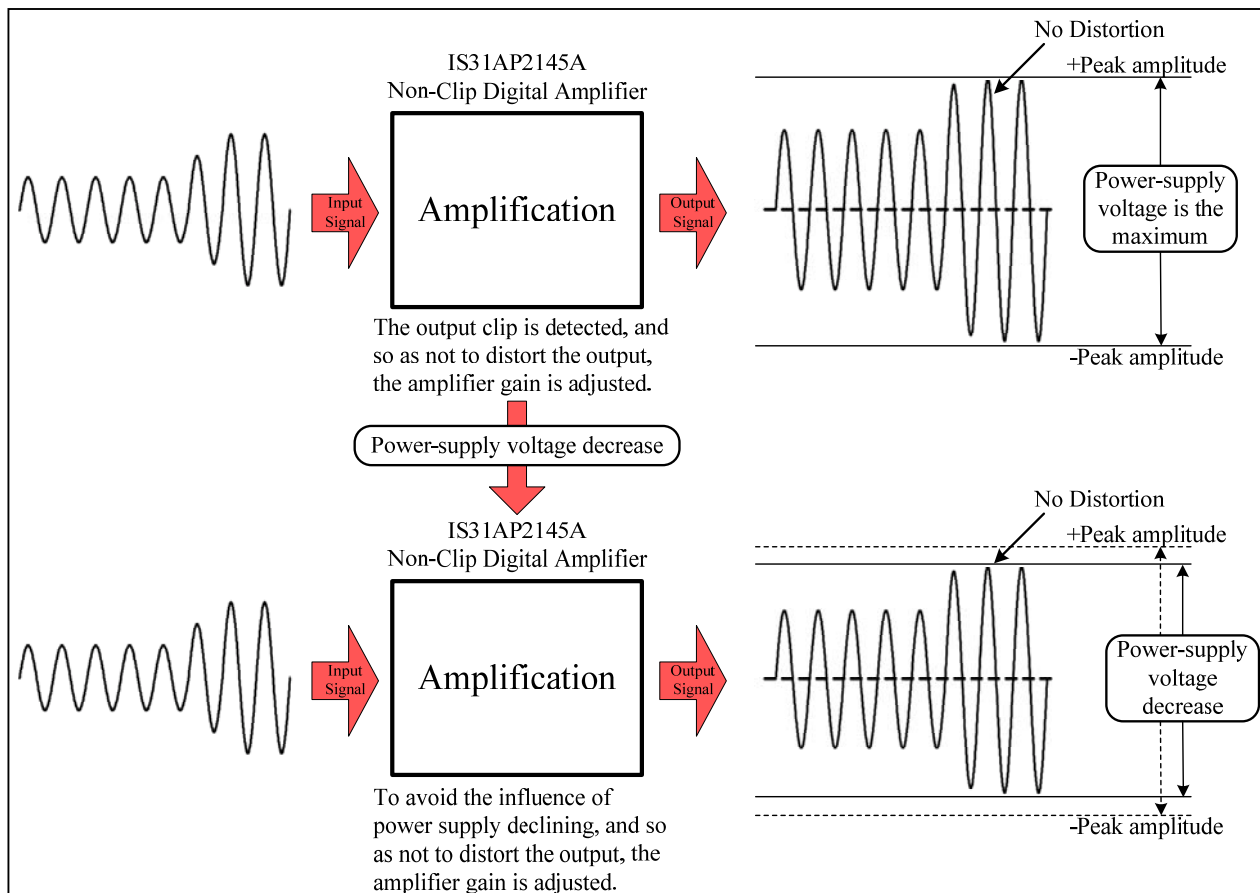

Figure 14 Operation of AGC Function

IS31AP2145A

The attack time and the release time of AGC control have two levels (refer to Table 1). They are selected by the voltage at the CTRL terminal (refer to Table 2). The attack time is a time interval that gain falls from 18dB to 10dB with a big signal input enough. And the release time is a time from target attenuation to no AGC attenuation.

Table 1 Attack Time and Release Time

AGC Mode	Attack Time	Release Time
AGC1 (Recommended)	45ms	2.6s
AGC2	10ms	1.2s

Assuming no limitation by the power supply, the audio output signal would be as in Figure 15.

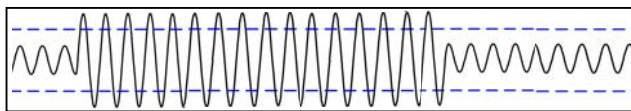

Figure 15 Assuming no Restriction from Power Supply, the Audio Output Signal

In normal operation without the AGC, the output is distorted because of the restriction from power supply, as shown in Figure 16.

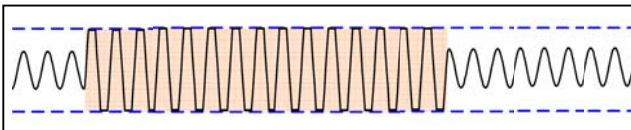

Figure 16 AGC Function Off

With the AGC function of IS31AP2145A, the optimum output power can be obtained along with the minimal distortion. The Figure 17 shows the outcome of AGC function.

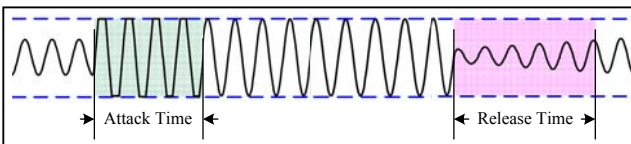

Figure 17 AGC Function On

CTRL TERMINAL FUNCTION

By setting the threshold voltage of each mode to CTRL terminal, the followings can be set: AGC1, AGC2, AGC OFF, and Shutdown Mode (Table 2 and Figure 18).

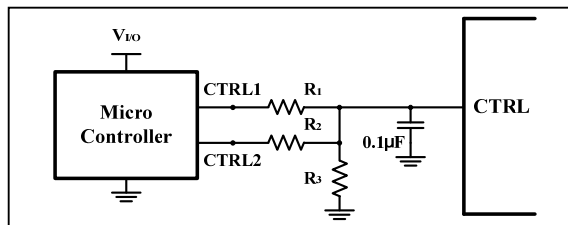

Figure 18 AGC Function Mode Setting

Table 2 Mode Setting

CTRL1	CTRL2	Mode
H	H	AGC1
H	GND	AGC2
GND	H	AGC OFF
GND	GND	Shutdown

“H” level indicates a microcomputer’s I/O port H level output voltage that is input to CTRL1 and CTRL2 terminals and GND indicates GND of the microcomputer.

GND level of the microcomputer must be the same as that of IS31AP2145A.

The control of CTRL terminal is based on I/O port H level output voltage of microcomputer that is connected.

Set resistance constants according to I/O port H level output voltage of each microcomputer as Table 3 below.

Table 3 Resistors Setting

V _{I/O}	1.8V	2.6V	2.8V	3.0V	3.3V	5.0V
R1	27kΩ	33kΩ	33kΩ	33kΩ	33kΩ	56kΩ
R2	56kΩ	68kΩ	68kΩ	68kΩ	68kΩ	120kΩ
R3	82kΩ	27kΩ	24kΩ	22kΩ	18kΩ	15kΩ

Functions of CTRL pin are designed with their control by two control pins (CTRL1 and CTRL3). Only a switching control between AGC1 Mode and Shutdown Mode is available when a single control terminal is used (Table 4 and Figure 19).

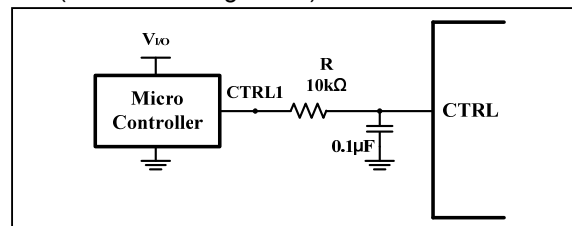

Figure 19 AGC1 Mode Circuit

Table 4 Mode Setting

CTRL1	Mode
H	AGC1
GND	Shutdown

SYSTEM TIMING

The CTRL terminal should be configured as the Figure 20. When in the Shutdown Mode, the level of the terminal must not be changed from GND level during t_{SD}. When the IS31AP2145A wakes up, the CTRL terminal must be set to H level first, then enter the setting mode.

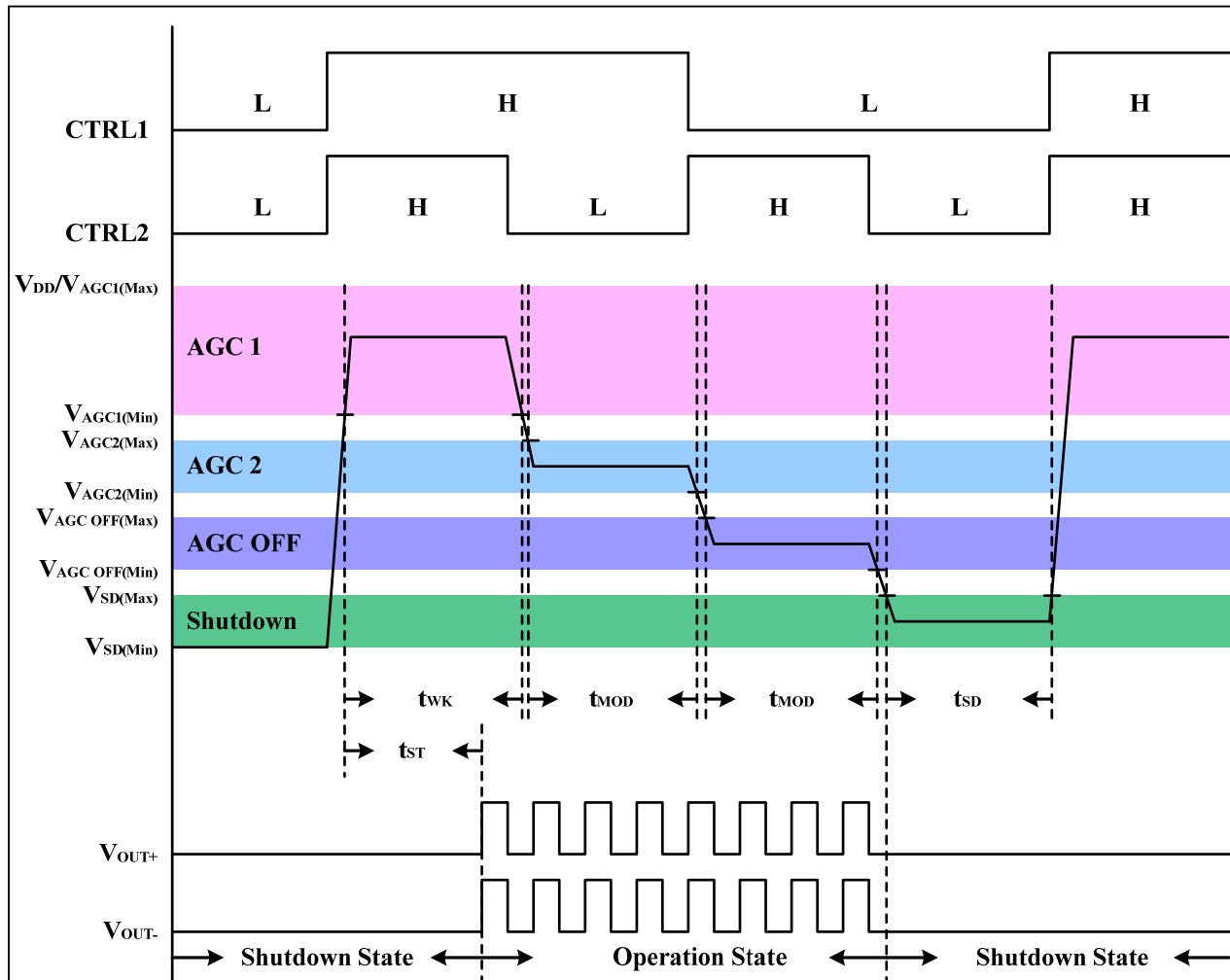

Figure 20 System Timing

INPUT CAPACITORS (C_{IN})

The input capacitors (C_{IN}) and internal resistor (R_{IN} = 28.5kΩ) form a high-pass filter with the corner frequency, f_c, determined in Equation (1).

$$f_c = \frac{1}{2\pi R_{IN} C_{IN}} \quad (1)$$

For example, in figure 1,
C_{IN} = 33nF, R_{IN} = 28.5kΩ,

So,
$$f_c = \frac{1}{2\pi \times 28.5k\Omega \times 33nF} \approx 169Hz$$

The capacitors should have a tolerance of ± 10% or better, because any mismatch in capacitance causes an impedance mismatch at the corner frequency and below.

DECOUPLING CAPACITOR (C_S)

The IS31AP2145A is a high performance class-D audio amplifier that requires adequate power supply decoupling to ensure the efficiency is high and total harmonic distortion (THD) is low. For higher frequency transients, spikes, or digital hash on the line, a good low equivalent-series-resistance (ESR) ceramic capacitor, typically 0.1μF, placed as close as possible to the device V_{DD} lead works best. Placing this decoupling capacitor close to the IS31AP2145A is very important for the efficiency of the class-D amplifier, because any resistance or inductance in the trace between the device and the capacitor can cause a loss in efficiency. For filtering lower frequency noise signals, a 1μF or greater capacitor placed near the audio power amplifier would also help.

IS31AP2145A

CLASSIFICATION REFLOW PROFILES

Profile Feature	Pb-Free Assembly
Preheat & Soak Temperature min (T _{smin}) Temperature max (T _{smax}) Time (T _{smin} to T _{smax}) (t _s)	150°C 200°C 60-120 seconds
Average ramp-up rate (T _{smax} to T _p)	3°C/second max.
Liquidous temperature (T _L) Time at liquidous (t _L)	217°C 60-150 seconds
Peak package body temperature (T _p)*	Max 260°C
Time (t _p)** within 5°C of the specified classification temperature (T _c)	Max 30 seconds
Average ramp-down rate (T _p to T _{smax})	6°C/second max.
Time 25°C to peak temperature	8 minutes max.

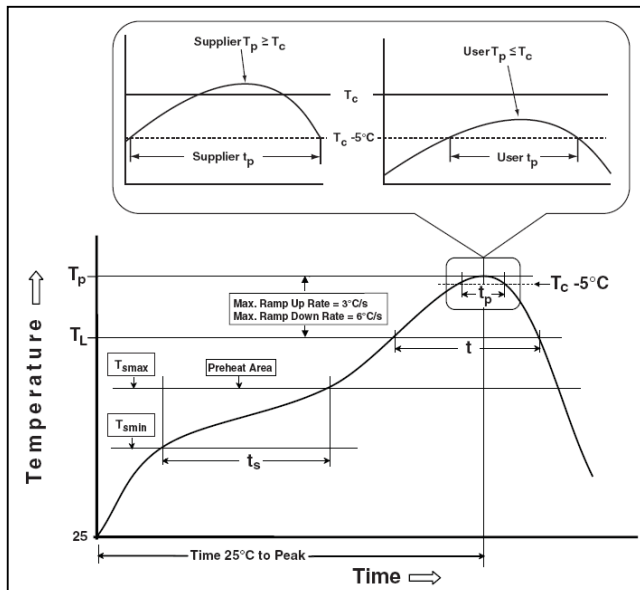
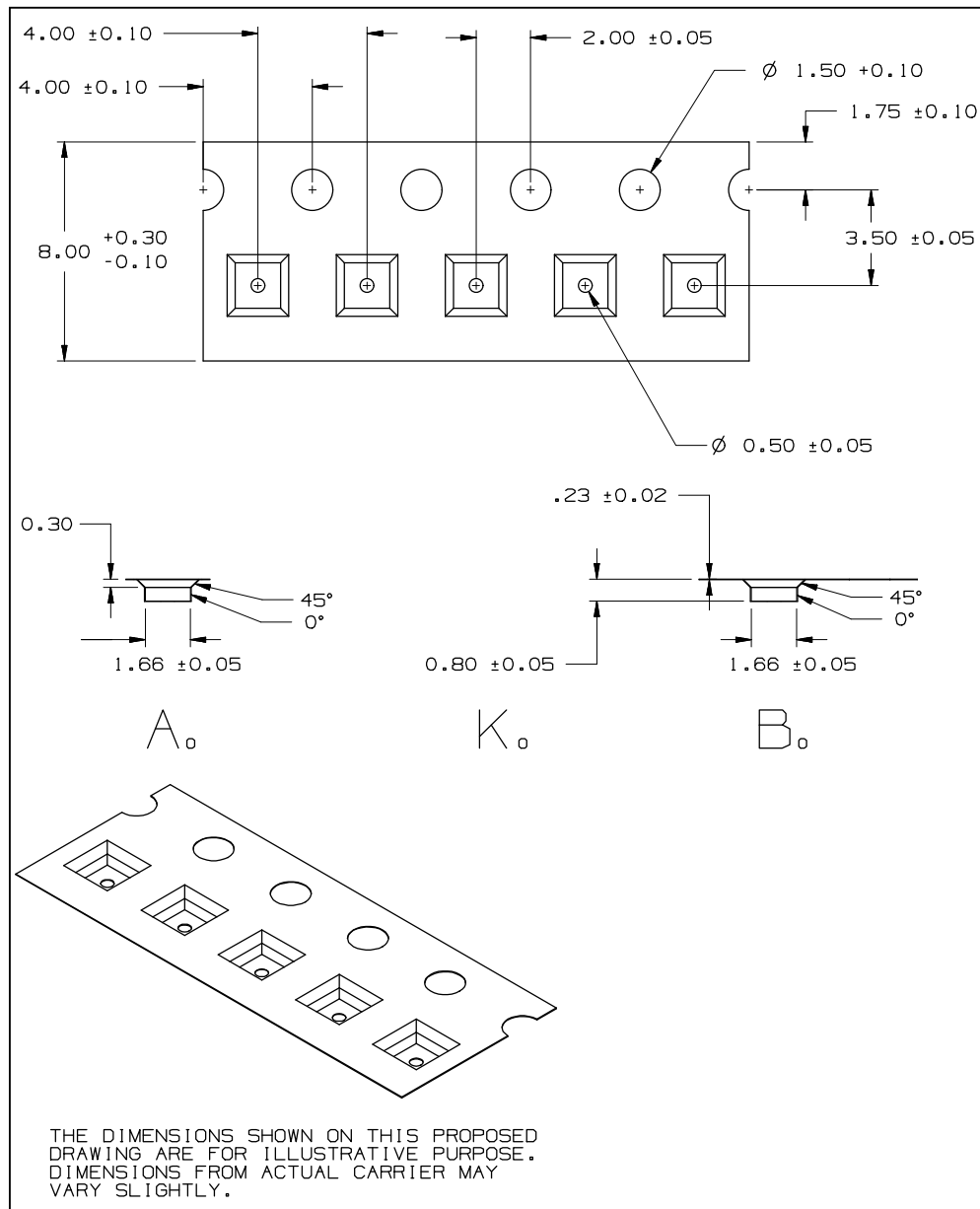

Figure 21 Classification Profile

IS31AP2145A

TAPE AND REEL INFORMATION



Note: All dimensions in millimeters unless otherwise stated.

IS31AP2145A

PACKAGING INFORMATION

UTQFN-9

