

# 1. Main

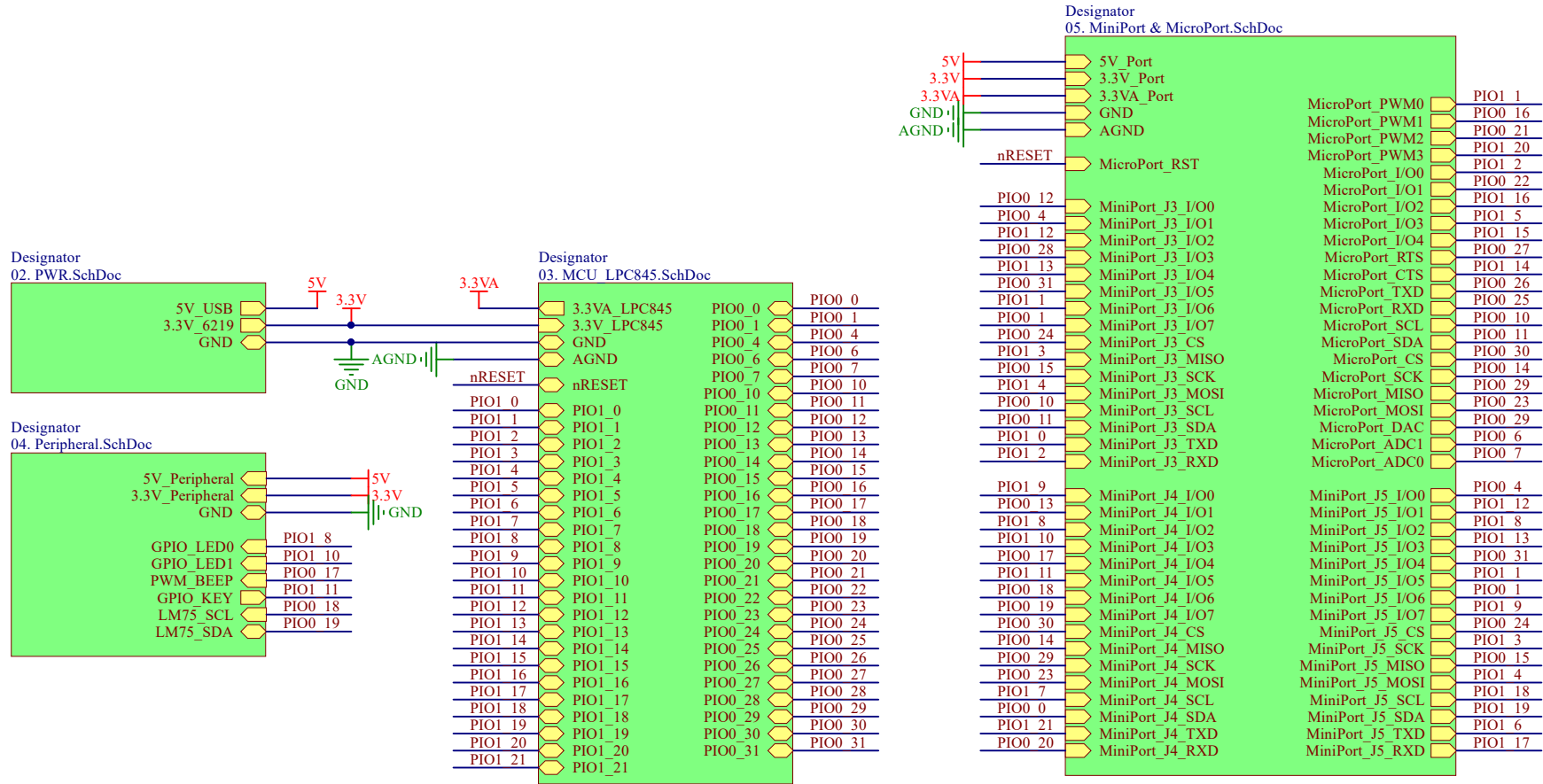

#	修改日期	修改内容
1		
2		
3		

## 2. PWR

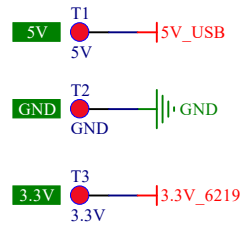
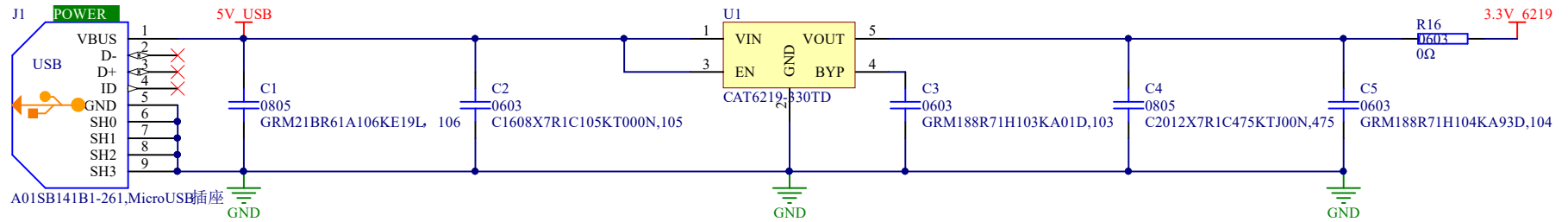
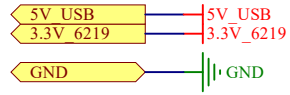

#	修改日期	修改内容
1		
2		
3		

### 3. MCU\_LPC845

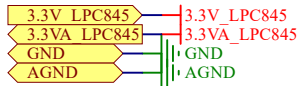

PIO0_0	PIO0_0
PIO0_1	PIO0_1
PIO0_4	PIO0_4
PIO0_6	PIO0_6
PIO0_7	PIO0_7
PIO0_10	PIO0_10
PIO0_11	PIO0_11
PIO0_12	PIO0_12
PIO0_13	PIO0_13
PIO0_14	PIO0_14
PIO0_15	PIO0_15
PIO0_16	PIO0_16
PIO0_17	PIO0_17
PIO0_18	PIO0_18
PIO0_19	PIO0_19
PIO0_20	PIO0_20
PIO0_21	PIO0_21
PIO0_22	PIO0_22
PIO0_23	PIO0_23
PIO0_24	PIO0_24
PIO0_25	PIO0_25
PIO0_26	PIO0_26
PIO0_27	PIO0_27
PIO0_28	PIO0_28
PIO0_29	PIO0_29
PIO0_30	PIO0_30
PIO0_31	PIO0_31

PIO1_0	PIO1_0
PIO1_1	PIO1_1
PIO1_2	PIO1_2
PIO1_3	PIO1_3
PIO1_4	PIO1_4
PIO1_5	PIO1_5
PIO1_6	PIO1_6
PIO1_7	PIO1_7
PIO1_8	PIO1_8
PIO1_9	PIO1_9
PIO1_10	PIO1_10
PIO1_11	PIO1_11
PIO1_12	PIO1_12
PIO1_13	PIO1_13
PIO1_14	PIO1_14
PIO1_15	PIO1_15
PIO1_16	PIO1_16
PIO1_17	PIO1_17
PIO1_18	PIO1_18
PIO1_19	PIO1_19
PIO1_20	PIO1_20
PIO1_21	PIO1_21

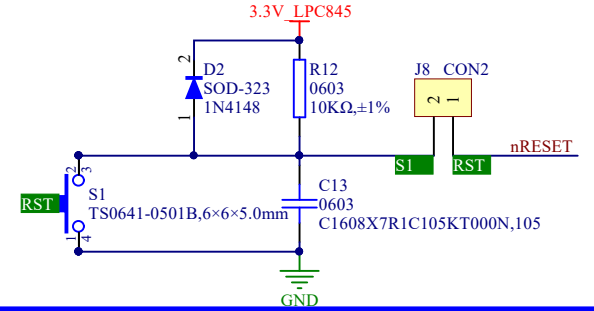
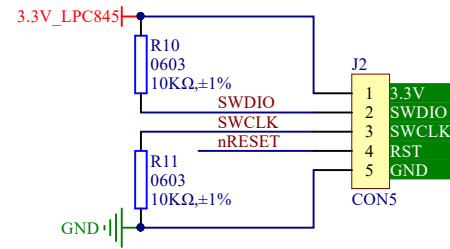
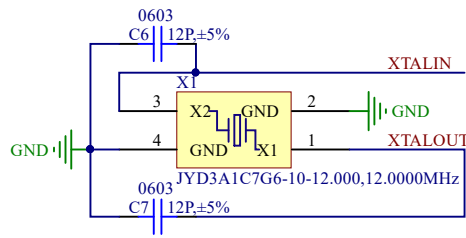

U2			
PIO0_0	48	PIO0_0/ACMP_11/TDO	15
PIO0_1	32	PIO0_1/ACMP_12/CLKIN/TDI	18
SWDIO	14	SWDIO/PIO0_2/TMS	20
SWCLK	12	SWCLK/PIO0_3/TCK	29
PIO0_4	6	PIO0_4/ADC_11/TRSTN/WAKEUP	31
nRESET	5	NRESET/PIO0_5	35
PIO0_6	46	PIO0_6/ADC_1/ACMPVREF	38
PIO0_7	45	PIO0_7/ADC_0	47
XTALIN	34	PIO0_8/XTALIN	1
XTALOUT	33	PIO0_9/XTALOUT	3
PIO0_10	17	PIO0_10/I2C0_SCL	64
PIO0_11	16	PIO0_11/I2C0_SDA	62
PIO0_12	4	PIO0_12	9
PIO0_13	2	PIO0_13/ADC_10	11
PIO0_14	49	PIO0_14/ACMP_3/ADC_2	22
PIO0_15	30	PIO0_15	24
PIO0_16	19	PIO0_16	36
PIO0_17	63	PIO0_17/ADC_9/DACOUT_0	37
PIO0_18	61	PIO0_18/ADC_8	43
PIO0_19	60	PIO0_19/ADC_7	44
PIO0_20	58	PIO0_20/ADC_6	56
PIO0_21	57	PIO0_21/ADC_5	59
PIO0_22	55	PIO0_22/ADC_4	
PIO0_23	51	PIO0_23/ADC_3/ACMP_4	
PIO0_24	28	PIO0_24	
PIO0_25	27	PIO0_25	
PIO0_26	23	PIO0_26	
PIO0_27	21	PIO0_27	
PIO0_28	10	PIO0_28/WKTCLKIN	
PIO0_29	50	PIO0_29/DACOUT_1	
PIO0_30	54	PIO0_30/ACMP_5	
PIO0_31	13	PIO0_31/CAPT_X0	
VDD_1		VDD_1	
VDD_2		VDD_2	
VDD_3		VDD_3	
VDDA		VDDA	
VSS_1		VSS_1	
VSS_2		VSS_2	
VSS_3		VSS_3	
VSSA		VSSA	
VREFN		VREFN	
VREFP		VREFP	

LPC845M301JBD64,LQFP-64

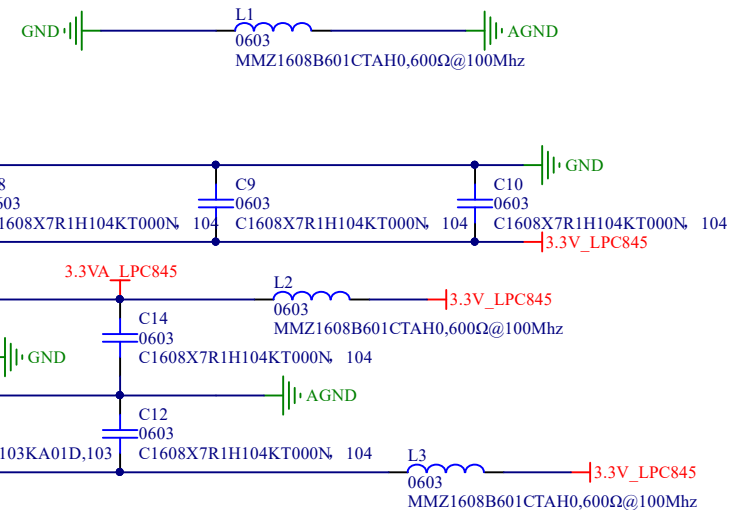

#	修改日期	修改内容
1		
2		
3		

# 4. Peripheral

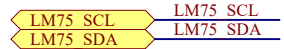
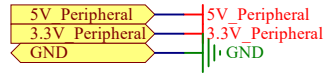

## LED电路

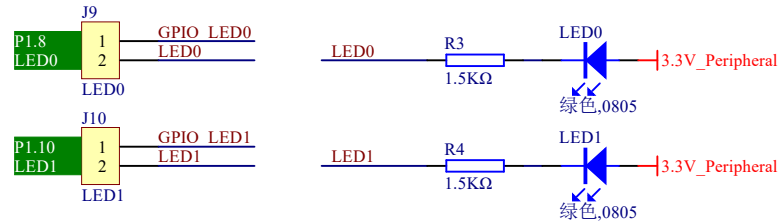

## 蜂鸣器电路

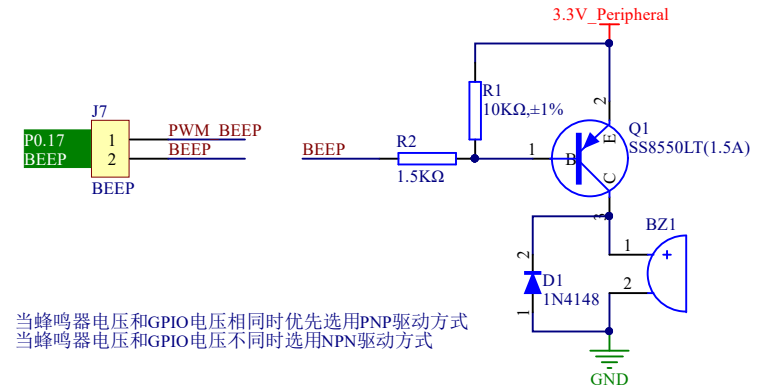

当蜂鸣器电压和GPIO电压相同时优先选用PNP驱动方式  
当蜂鸣器电压和GPIO电压不同时选用NPN驱动方式

## 按键与加热电路

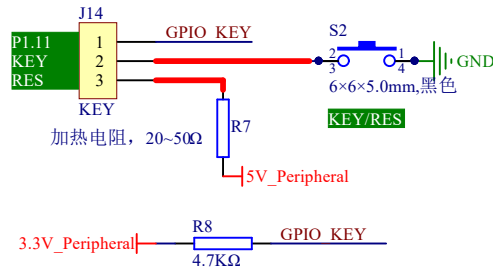

## 数字温度传感器电路

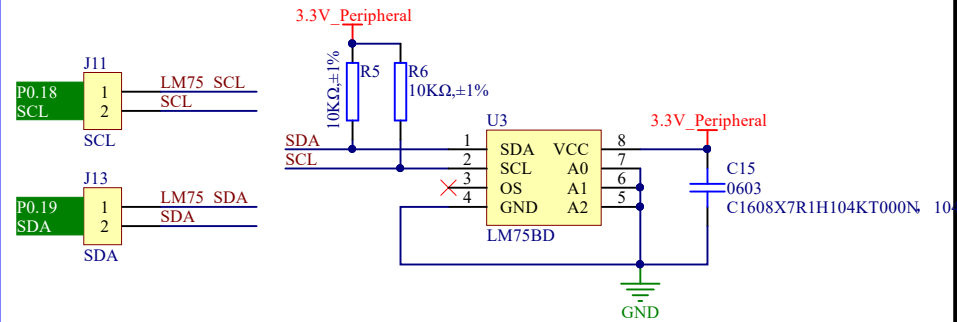

#	修改日期	修改内容
1		
2		
3		

# 5. MiniPort & MicroPort

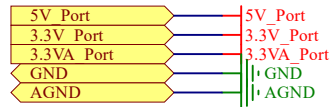

MicroPort RST	MicroPort RST
MicroPort I/O0	MicroPort I/O0
MicroPort I/O1	MicroPort I/O1
MicroPort I/O2	MicroPort I/O2
MicroPort I/O3	MicroPort I/O3
MicroPort I/O4	MicroPort I/O4
MicroPort PWM0	MicroPort PWM0
MicroPort PWM1	MicroPort PWM1
MicroPort PWM2	MicroPort PWM2
MicroPort PWM3	MicroPort PWM3
MicroPort RTS	MicroPort RTS
MicroPort CTS	MicroPort CTS
MicroPort TXD	MicroPort TXD
MicroPort RXD	MicroPort RXD
MicroPort SCL	MicroPort SCL
MicroPort SDA	MicroPort SDA
MicroPort CS	MicroPort CS
MicroPort SCK	MicroPort SCK
MicroPort MISO	MicroPort MISO
MicroPort MOSI	MicroPort MOSI
MicroPort DAC	MicroPort DAC
MicroPort ADC1	MicroPort ADC1
MicroPort ADC0	MicroPort ADC0

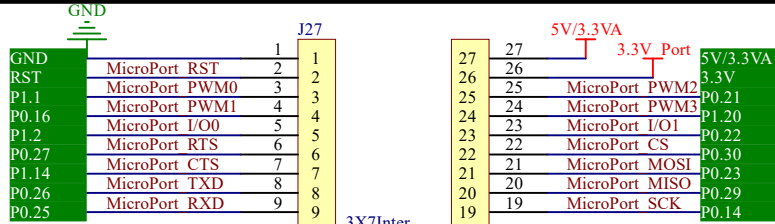

MicroPort接口I2C接口与J3共用

10	P1.5
11	P1.16
12	P0.10
13	P0.11
14	P1.15
15	P0.29
16	P0.6
17	P0.7
18	GND

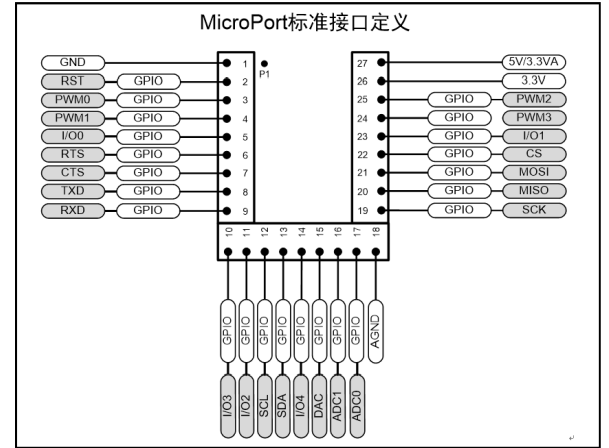
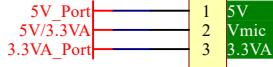

MiniPort J3 I/O0	MiniPort J3 I/O0
MiniPort J3 I/O1	MiniPort J3 I/O1
MiniPort J3 I/O2	MiniPort J3 I/O2
MiniPort J3 I/O3	MiniPort J3 I/O3
MiniPort J3 I/O4	MiniPort J3 I/O4
MiniPort J3 I/O5	MiniPort J3 I/O5
MiniPort J3 I/O6	MiniPort J3 I/O6
MiniPort J3 I/O7	MiniPort J3 I/O7
MiniPort J3 CS	MiniPort J3 CS
MiniPort J3 SCK	MiniPort J3 SCK
MiniPort J3 MISO	MiniPort J3 MISO
MiniPort J3 MOSI	MiniPort J3 MOSI
MiniPort J3 SCL	MiniPort J3 SCL
MiniPort J3 SDA	MiniPort J3 SDA
MiniPort J3 TXD	MiniPort J3 TXD
MiniPort J3 RXD	MiniPort J3 RXD

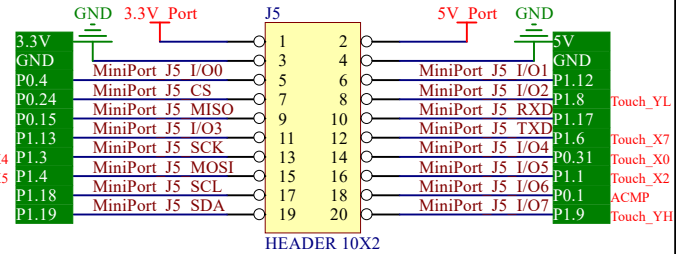
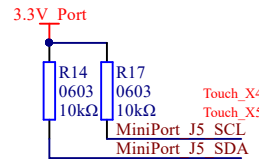
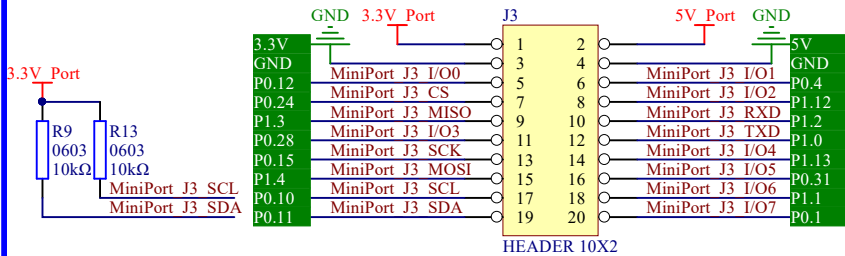

MiniPort J4 I/O0	MiniPort J4 I/O0
MiniPort J4 I/O1	MiniPort J4 I/O1
MiniPort J4 I/O2	MiniPort J4 I/O2
MiniPort J4 I/O3	MiniPort J4 I/O3
MiniPort J4 I/O4	MiniPort J4 I/O4
MiniPort J4 I/O5	MiniPort J4 I/O5
MiniPort J4 I/O6	MiniPort J4 I/O6
MiniPort J4 I/O7	MiniPort J4 I/O7
MiniPort J4 CS	MiniPort J4 CS
MiniPort J4 SCK	MiniPort J4 SCK
MiniPort J4 MISO	MiniPort J4 MISO
MiniPort J4 MOSI	MiniPort J4 MOSI
MiniPort J4 SCL	MiniPort J4 SCL
MiniPort J4 SDA	MiniPort J4 SDA
MiniPort J4 TXD	MiniPort J4 TXD
MiniPort J4 RXD	MiniPort J4 RXD

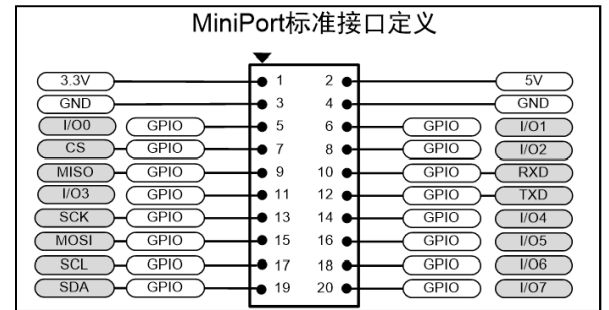
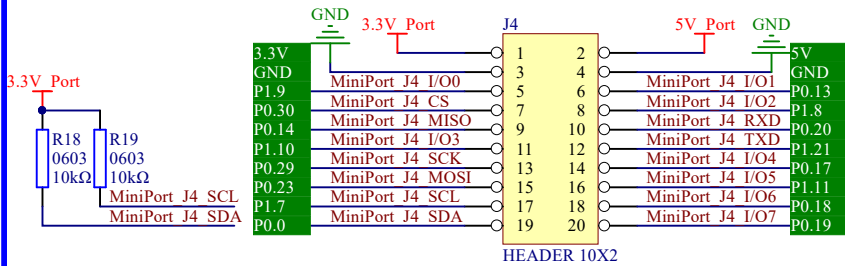

MiniPort J5 I/O0	MiniPort J5 I/O0
MiniPort J5 I/O1	MiniPort J5 I/O1

MiniPort J5 I/O2	MiniPort J5 I/O2
MiniPort J5 I/O3	MiniPort J5 I/O3
MiniPort J5 I/O4	MiniPort J5 I/O4
MiniPort J5 I/O5	MiniPort J5 I/O5
MiniPort J5 I/O6	MiniPort J5 I/O6
MiniPort J5 I/O7	MiniPort J5 I/O7
MiniPort J5 CS	MiniPort J5 CS

MiniPort J5 MISO	MiniPort J5 MISO
MiniPort J5 SCK	MiniPort J5 SCK
MiniPort J5 MOSI	MiniPort J5 MOSI
MiniPort J5 SCL	MiniPort J5 SCL
MiniPort J5 SDA	MiniPort J5 SDA
MiniPort J5 TXD	MiniPort J5 TXD
MiniPort J5 RXD	MiniPort J5 RXD

#	修改日期	修改内容
1		
2		
3		